

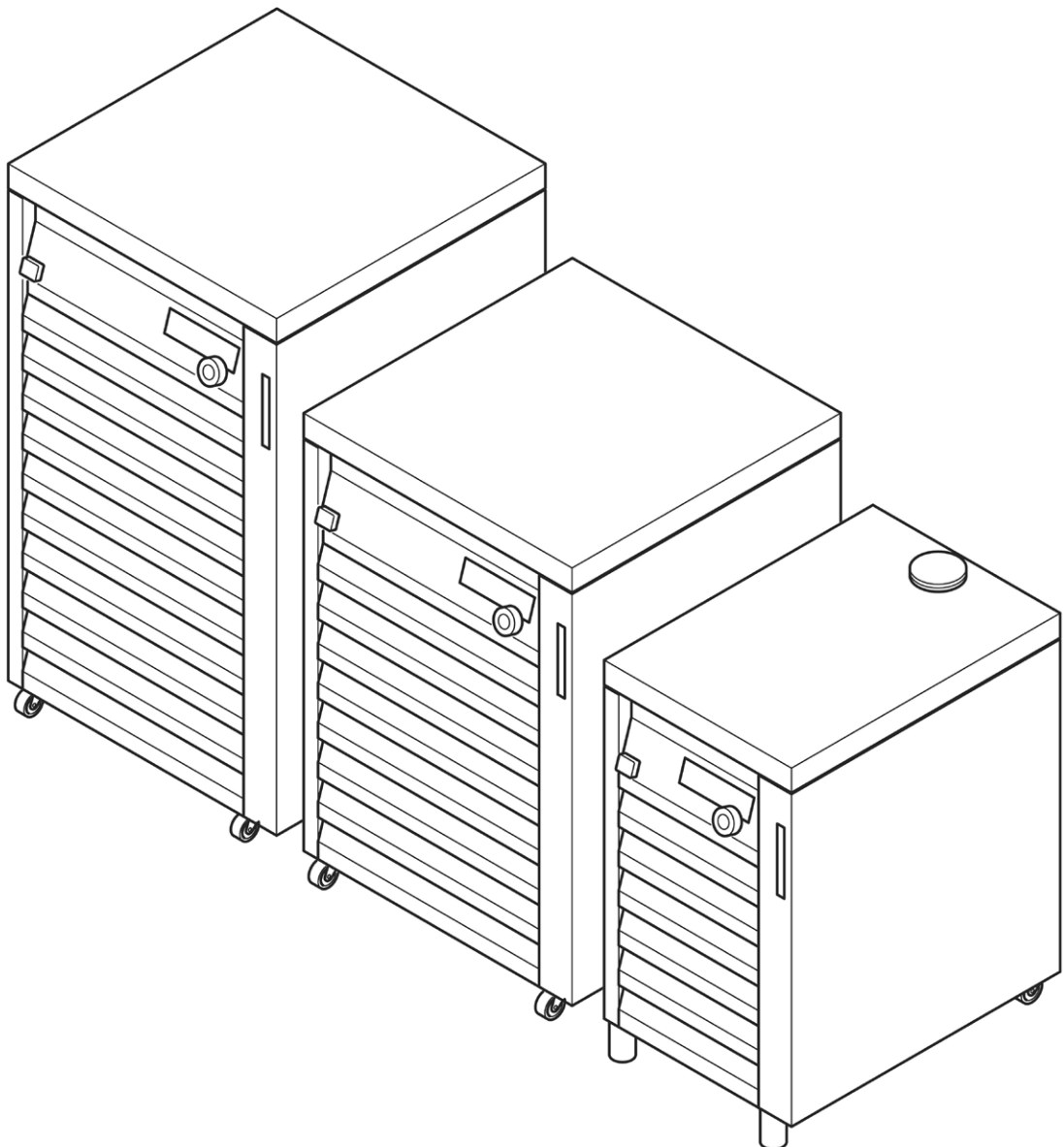

Recirculating Chiller F-305 / F-308 / F-314

Technical data sheet

The BUCHI recirculating chillers are meant to be used with laboratory equipment that requires coolant flow such as rotary evaporators, parallel evaporators, Kjeldahl- and extraction products. The F-300 line is specifically designed for seamless integration into a BUCHI Rotavapor® R-300 system. The temperature can conveniently be set by the interface. Furthermore, it offers ECO-mode, temperature lock and instant start with dynamic pressure adjustment without waiting until the chiller reaches its set temperature.



Overview

The Recirculating Chiller F-305 / F-308 / F-314 cover a temperature range of -10 to + 25 °C. The chillers differ in the cooling capacity to support various laboratory instruments.

Recommended chiller when working at 15 °C cooling and 20 °C ambient temperature

	F-305	F-308	F-314
Cooling capacity at 15 °C	550 W	900 W	1400 W
Supported lab-size rotary evaporator	1	2	3 – 4
Supported parallel evaporator	-	1	2
Supported extraction system	-	1	2
Supported Kjeldahl products	-	1 stand-alone	1 sampler system

Recommended chiller when working at other cooling temperatures

The following graph shows the relation between cooling capacity and temperature at 25 °C ambient conditions; the lower the temperature, the lower the cooling capacity. In addition to the ambient temperature, the cooling capacity is influenced by humidity, tubing length, tubing diameter, etc.

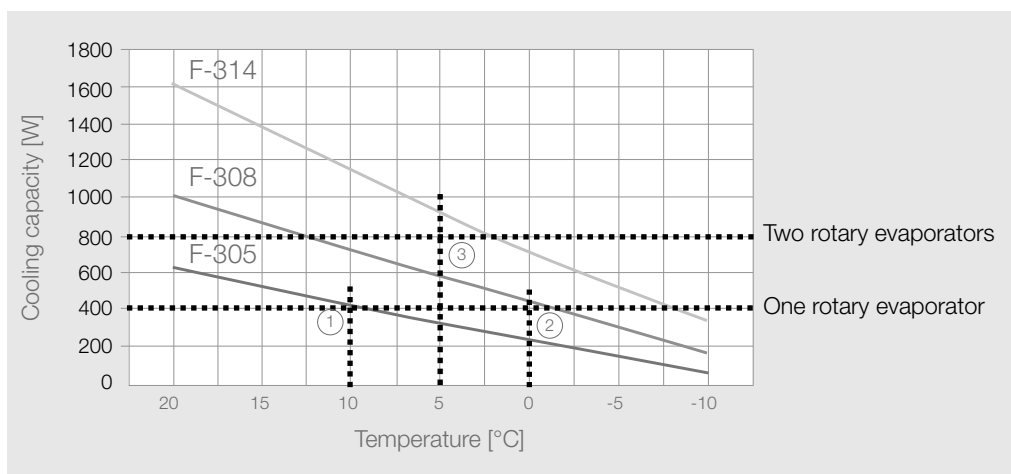

Typically required cooling capacity for laboratory instruments:

Rotary evaporator: 400 W

Extraction units: 550 W

Kjeldahl unit: 700 W

Parallel evaporation: 600 W

Examples:

① Distillation with one rotary evaporator at 10 °C ▶ F-305

② Distillation with one rotary evaporator at 0 °C ▶ F-308

③ Distillation with two rotary evaporators at 5 °C ▶ F-314

Order code

Choose the configuration according to your needs:

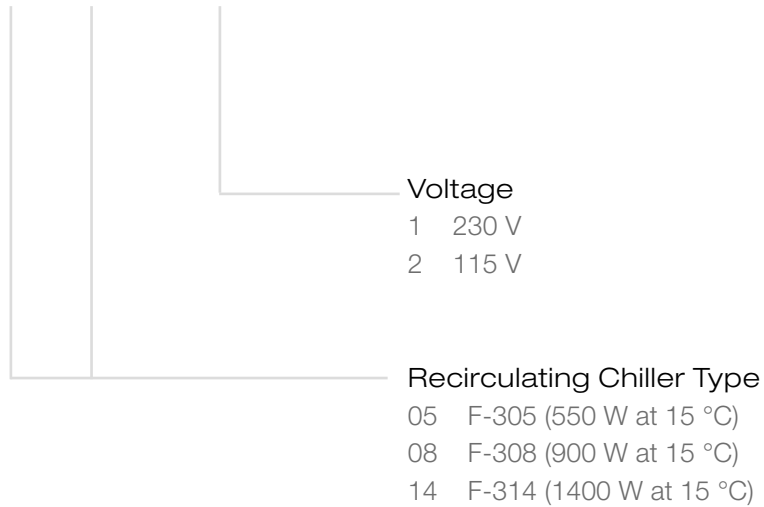

Scope of delivery

The recirculating chillers are delivered ready to use and are complete of:

Components	F-305	F-308	F-314
Hose clamp	4	4	4
Power cord	1	1	1
Instruction manual on CD	1	1	1
Control cable, 2 m	1	1	1
Hose barb, Ø 8 mm	2	2	—
Hose barb, Ø 9.5 mm	—	2	2
Hose barb, Ø 13.5 mm	—	—	2

Technical data

	F-305	F-308	F-314
Dimensions (W × H × D)	280 × 500 × 400 mm	400 × 580 × 500 mm	400 × 660 × 500 mm
Weight	31 kg	41 kg	52 kg
Cooling capacity at 15 °C*	550 W	900 W	1400 W
Cooling capacity at 10 °C*	440 W	730 W	1150 W
Cooling capacity at 0 °C*	250 W	450 W	720 W
Cooling capacity at -10 °C*	80 W	180 W	350 W
Temperature range	-10 °C to +25 °C	-10 °C to +25 °C	-10 °C to +25 °C
Power consumption (max.)	800 W	1100 W	1500 W

	F-305	F-308	F-314
Supply voltage	230 VAC ± 10 %	230 VAC ± 10 %	230 VAC ± 10 %
(According to order code)	115 VAC ± 10 %	115 VAC ± 10 %	115 VAC ± 10 %
Frequency 230V	50 – 60 Hz	50 – 60 Hz	50 – 60 Hz
115V	60 Hz	60 Hz	60 Hz
Temperature display	resolution 0.1 °C	resolution 0.1 °C	resolution 0.1 °C
Ambient temperature	5 – 35 °C	5 – 35 °C	5 – 35 °C
Refrigerant	R 134a	R 134a	R 134a
Temperature regulation accuracy	+/-1 °C	+/-1 °C	+/-1 °C
Tank volume	3.0 L	4.5 L	6.5 L
Hose connections	8 mm	8 + 9.5 mm	9.5 and 13.5 mm
Pump pressure	0.6 bar	0.6 bar	1 bar
Flow rate	2.5 L/min	3 L/min	11 L/min

* Measured at 20 °C ambient temperature, typically required cooling capacity for a rotary evaporator is 400 W

Compatibility and communication requirements with F-305 / F-308 / F-314

Interface / Vacuum Controller	Compatibility / Mode	Communication requirements
I-300 / I-300 Pro	Yes controlled	VacuBox 2x Communication cable. BUCHI COM 6p (11058705 (0.3 m) or 11058707 (1.8 m) or 11058708 (5 m) or 11064090 (15 m)) Power is supplied through connection with other appropriate peripherals
I-100	Yes on/off	Communication cable. Mini-DIN 6p to RJ45 (11060649 (1.5 m) or 11064104 (3 m)) Power adapter (11060669)
V-850 / V-855	Yes on/off	Communication cable. Mini-DIN 6p to RJ45 (11060649 (1.5 m) or 11064104 (3 m)) Power adapter (11060669)
V-800 / V-805	—	—

Explanation of terms

controlled	Recirculating Chiller is turned on/off and the temperature can be set via the interface. The actual temperature is displayed on the interface. Additional features when the system is operating in „controlled“ mode are listed as follows.
on/off	Recirculating Chiller is automatically turned on/off via the interface.
—	Connection not possible

Recirculating Chiller F-305 / F-308 / F-314 features

The Recirculating Chillers F-305 / F-308 / F-314 offer various features when operating stand-alone or as part of a Rotavapor® R-300 system in conjunction with the Interface I-300 or I-300 Pro.

Feature	Description	With Interface
Temperature setting on chiller	Set the temperature in 0.1 °C increments using the navigation knob. Actual and set temperature is shown on the integrated display.	
Temperature lock	Lock the set temperature with a push of the navigation knob to avoid unintentional changes.	
Remote control with interface	In addition to the setting of the chiller, the temperature can conveniently be set on the central interface thus showing all process parameters at a glance.	●
Remote monitoring on smartphone	The Rotavapor® App for iOS, Android and Windows offers push notifications, live view and charting of all process parameters on smartphones.	●
Dynamic operation	The distillation process can be started instantly when using the solvent library mode. While the chiller reaches its set temperature, the vacuum is dynamically adjusted.	●
Automatic stop	The chiller can be configured to stop automatically when the distillation process is terminated.	●
ECO-mode	Alternatively to the automatic stop the ECO-mode switches the chiller into a stand-by mode when not in use. The temperature increases by a definiable ΔT to be cooled down to the set temperature periodically (see graph below).	●

* Only applicable when used in combination with Interface I-300 or I-300 Pro

Eco-mode

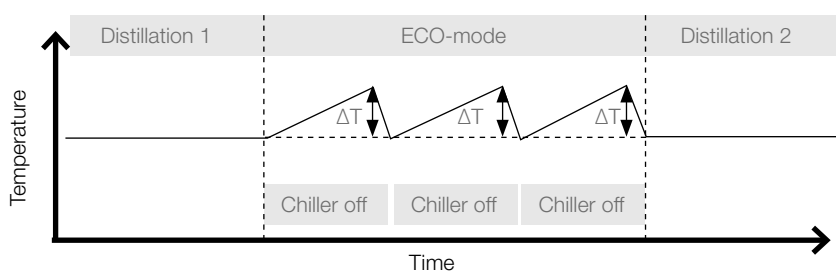

Feature comparison (F-305 / F-308 / F-314 and Interface)

Features	I-300 / I-300 Pro	I-100	V-850 / V-855	V-800 / V-805
Eco-mode	●			
Setting and viewing the temperature via interface	●			
Automatic mode	●		●	
Dynamic distillation (only when connected to R-300 Rotavapor® and vacuum pump)	●			
Remote monitoring on smartphone	●			

All Recirculating Chillers at a glance

The BUCHI recirculating chiller portfolio is completed with the F-100 line. The following table provides an overview of the different features.



F-100
300W / 10 °C

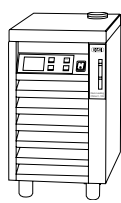

F-105
530 W / 15 °C

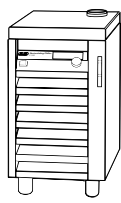

F-305
550 W / 15 °C

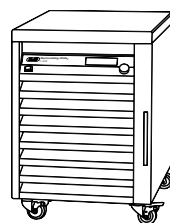

F-308
900 W / 15 °C

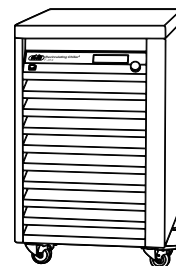

F-314
1400 W / 15 °C

	F-100	F-105	F-305	F-308	F-314
Cooling capacity at 15 °C	400 W	530 W	550 W	900 W	1400 W
Temperature range	Fix at 10 °C	-10 °C to +25 °C	-10 °C to +25 °C	-10 °C to +25 °C	-10 °C to +25 °C
Eco mode to save energy	-	-	●	●	●
Temperature lock	-	-	●	●	●
Recommended BUCHI Rotavapor® line	Rotavapor® R-100	Rotavapor® R-100	Rotavapor® R-300	Two Rotavapor® R-300	Two Rotavapor® R-300
ON/OFF control via interface on recom. Rotavapor®	-	●	●	●	●
Temperature setting via interface on recom. Rotavapor®	-	-	●	●	●
Other applications	Small distillation apparatus	Small distillation apparatus	Small distillation apparatus	· Kjeldahl · Extraction · Parallel evaporator	· Parallel evaporator at low temperature · Kjeldahl systems

Order number

Communication cable. BUCHI COM, 1.8 m, 6p Connection between Rotavapor R-300/VacuBox and Vacuum Pump V-300 or Rotavapor R-300/ VacuBox and Recirculating Chiller F-305/F-308/F-314.	11058707
Communication cable. BUCHI COM, 5.0 m, 6p Connection between Rotavapor R-300/VacuBox and Vacuum Pump V-300 or Rotavapor R-300/ VacuBox and Recirculating Chiller F-305/F-308/F-314.	11058708
Communication cable. BUCHI COM, 15 m, 6p Connection between Rotavapor R-300/VacuBox and Vacuum Pump V-300 or Rotavapor R-300/ VacuBox and Recirculating Chiller F-305/F-308/F-314.	11064090
Communication cable. Mini-DIN 6p to RJ45, 1.5 m Connection between Vacuum Controller V-850/V-855 and Vacuum Pump V-300 or between Vacuum Controller V-850/V-855 and Recirculating Chiller F-305/F-308/F-314.	11060649
Communication cable. Mini-DIN 6p to RJ45, 3 m Connection between Vacuum Controller V-850/V-855 and Vacuum Pump V-300 or between Vacuum Controller V-850/V-855 and Recirculating Chiller F-305/F-308/F-314.	11064104
Coupling, set. Quick-release coupling, 8 mm, set of 2 Use: connection of two cooling tubes together.	042885
Distribution piece. T-piece incl. shut off valve, hose barb Ø 9 mm Use: to connect two peripherals with one recirculating chiller	037742
Tubing. Nylflex, PVC-P, Ø8/14 mm, cross-linked, transparent, per m Use: Vacuum, cooling media, feeding (Industrial Rotavapor).	004113
Tubing. Synthetic rubber, Ø 11/23 mm, black, per m Use: insulation of cooling tubing (004133) for Laboratory Rotavapor.	028696
Tubing. Synthetic rubber, Ø15/27 mm, black, per m Use: insulation of cooling tubing (004134) for Industrial Rotavapor.	11056888
Tubing. Silicone, Ø10/14 mm, transparent, per m Use: Cooling media. For example: Industrial Rotavapor.	004134
Tubing. Silicone, Ø6/9mm, transparent, per m Use: Cooling media. For example: Laboratory Rotavapor.	004133

Wear parts

Order number

Hose barb. Bent, GL14, incl. silicone seal	018916
Hose barb, set. 3 pcs, bent, GL14, silicone seal Content: Hose barbs, seals.	041987
Hose barbs, set. 4 pcs, bent GL14, silicone seal Content: Hose barbs, cap nuts, seals.	037287
Hose barbs, set. 4 pcs, straight, GL14, silicone seal Content: Hose barbs, cap nuts, seals.	037642
Hose barbs, set. 6 pcs, bent (4), straight (2), GL14, silicone seal Content: Hose barbs, cap nuts, seals.	038000

Order number

Hose barbs, set. 2 pcs, bent (1), straight (1), GL14, silicone seal

041939

Content: Hose barbs, cap nuts, seals.

Seals, set. 20 pcs, for hose barbs GL14, silicone, red

040023

